

LD220WCM

WIRELESS CONTROL MODULE

Bluetooth dimmer



- 0-200VA
- Wireless dimming via app for Android / iOS
- Dimming with momentary switch push button
- Astro and time schedule features
- Extremely small and for wallbox montage

LD220WCM

Bluetooth controlled LED dimmer

THE POPULAR SWEDISH DEVELOPED dimmer series LD, now gets a WCM option (V-4022010WCM) that adds wireless control features based on the standard Bluetooth protocol found in most modern smartphones and tablets. Download the Casambi app for Android (requires version 4,4+) or Apple's iOS and take control of your luminaires and get full dimming control through your smartphone.

VADSBO  powered by CASAMBI — A complete ecosystem for all lighting



LD220WCM
E 13 602 42

THE DIMMER

Push button switch function

Connect a regular momentary switch and get synchronized control over whichever LD220WCM dimmers you wish. The switch can be tailored on your smartphone to get control over a unit or a group. Or even any other LD220WCM device that is connected to Bluetooth MESH network. Programming is made simple by using your smartphone. With this support it means that you can easily get control of your LD220WCM even if your phone or tablet would be shut off.

230V installation

The bluetooth dimmer LD220WCM is designed to dim the LEDs, therefore the low start up power at 0VA. It is very flexible in the sense that it is able to dim all 230V installations up to 200VA, whether it is LED, halogen, incandescent lamps or low energy.

Flexibility

Thanks to the market's most common communication protocol are broadly available in all smartphones / tablets today the integrated Bluetooth and MESH technology offers LD220WCM endless possibilities! This provides the easiest setup of any installation. With the LD220WCM, any combination of CV and CC LED can be mixed and controlled from the same simple intuitive interface using your smartphone / tablet.

Well-ried

LD220WCM has been tested in the light & luminaires key that we put together on the next page. The dimmer is extremely small with the dimensions Ø50x15,5 mm and is therefore perfectly suited for wallbox montage. The product also has fastening holes for external montage. LD220WCM is equipped with a "nose" to enable easy removal from wallbox. It is also equipped with a terminal block with reliable screws for connecting wires.

THE APP

Dimming through the free app

You get simple, intuitive dimming and on/off function through the free Casambi app.

Astro function and time schedule

Astro function means that the lighting follows the sunrise / sunset. By choosing your geographic location, you are given the ability to control your lighting after your sunrise / sunset. The time schedule and astro function is set via the app. The settings is then stored in the LED control gears memory and will work after the gear's internal clock.

Group and scene settings

Each control gear in your installation can be controlled individually. Most common is that the user wants to control a group of luminaires simultaneously to easily dim an entire room. The control gears are grouped by the app, and you can easily dim / control them simultaneously.

Additional control options

Take a photo of your living room or conference room, then combine it with the app to tie the luminaire through the photo. Now you can easily get control of your selected room by pressing the luminaire and then drag the slider that appears. It's that easy.

Access and share settings

The internal communication between the control gears is protected by asymmetric keys and an encryption scheme. The first time your LD220WCM dimmers are being used, they are paired to a master device (smartphone or tablet). The network or the device can then be shared with the number of units you want by entering the password or leave it open for access by any device desired. Simple and user friendly.

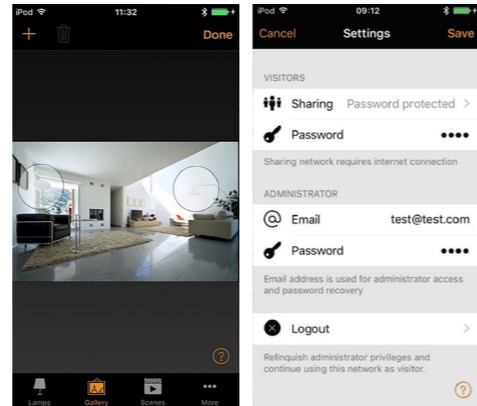

THE BLUETOOTH SYSTEM

Range

LD220WCM works with MESH technology, which means that the units are talking to each other, and you only need to have coverage to one single unit. By using the MESH network technology you only need to be within range (normally 30 meter) of a single unite to have control over all units in your installation. Because of the MESH technology you can build large scale installations with up to 127 units and easily control them all from your smartphone or tablet.

Continually updated control gears

The software in your LD220WCM is easily updated by

connecting it through your smartphone or tablet to the internet. That gives you access to the latest features and updates on your control gears. Through the MESH network your control gears will communicate with each other and update each other.

No router

The Bluetooth system does not require an external router because the communication is stored in the Bluetooth cloud. This is cost efficient, gives fast communication and is very practical.

Scalable system

LD220WCM is included in the Vadsbo wireless system and other products such as LCC60WCM is integrable.

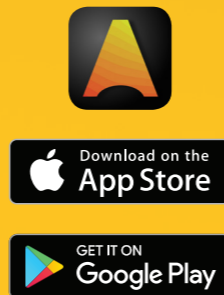

LIGHT & LUMINAIRES KEY

Vadsbo have tested dimmable 230V LED lights and luminaires against the trailing edge dimmer LD220WCM and rated the combination between 0-5 according to the rating explained at the bottom.

Light source	Base	Load	Manufacture	E-number/Productno.	Rating	Quantity/dimmer
	GU10	3.3W	Osram	82 911 67	5	42
	GU10	5W	Osram	82 911 88	5	30
	GU10	5.5W	Osram	83 343 25	5	27
	E14	6W	Osram	82 911 29	5	20
	E27	6W	Osram	82 911 06	5	28
	E27	9W	Osram	83 343 46	5	17
	GU10	5W	Hide-a-Lite	83 807 60	5	23
	GU10	5W	Hide-a-Lite	83 847 07	4	20
	GU10	6W	Zebra	82 907 40	5	25
	E14	4W	LEDsystem Scandinavia	82 916 55	5	42
	E27	6W	LEDsystem Scandinavia	-	5	23
	E27	8W	LEDsystem Scandinavia	82 918 69	5	17
	GU10	8.5W	Verbatim	82 907 03	5	15
	E27	3.6W	Star Trading	352-53	5	40
	E27	10W	Star Trading	358-68	3	8

2016-05-25

The numbers in yellow show the recommended maximum number of lamps / luminaires per dimmer.

Luminaires	Load	Manufacture	E-number	Rating	Quantity/dimmer
	10W	SG	74 630 29	5	15
	2x8W	Hide-a-Lite	74 643 50	5	9
	5W	Hide-a-Lite	74 505 86	5	18
	5W	Hide-a-Lite	74 639 26	5	18
	6W	Hide-a-Lite	74 643 62	5	26
	8W	Hide-a-Lite	74 631 80	5	18
	7W	Maxel	74 646 57	5	16
	7W	Maxel	74 646 55	5	18
	7.5W	Maxel	74 633 00	4	16
	7.5W	Maxel	74 633 04	4	16
	7.5W	Maxel	74 006 02	5	18
	7.5W	Maxel	74 633 02	4	16
	6W	Level Light	LD370	5	18
	5W	LEDsystem Scandinavia	74 646 02	5	20
	6W	LEDsystem Scandinavia	74 646 54	5	13

Rating explanation:

- 5) Excellent combination
- 4) The light source is dimmed in a good way
- 3) The light source is dimmed.
 - Flicker / hum may appear in the bottom position
- 2) The light source is dimmed.
 - Flicker / hum may appear in different positions
- 1) See 2) Too short-ranged dimming
- 0) Improper combination

Note

The grades only apply to the light / luminaires power as load. Depending on the brand, the LED and low-energy light may consume up to twice the rated power (reactive power).

Light & luminaires key

The light & luminaires key of Vadsbo is updated regularly with new lights and luminaires. To see the latest version, please visit our website www.vadsbo.net/ljusnyckel. There you can also find older tests on light / luminaires.

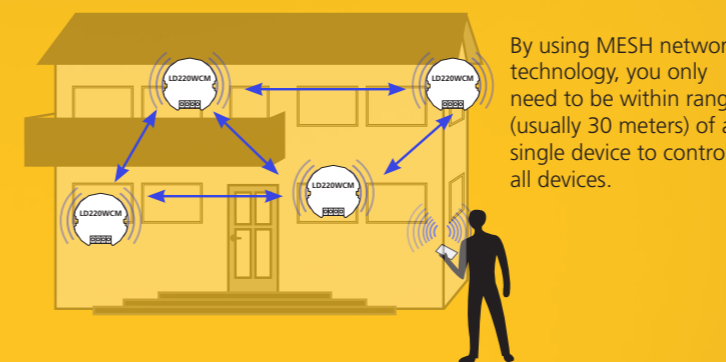

TECHNICAL SPECIFICATION

Designation	LD220WCM
Load	0-200VA
E-number	13 602 42
Part number	V-4022010WCM
Input	220-240V
Standby Power	0.2W
Max current	0,87 A
Frequency	50/60Hz
Dimming control	One or more push button switch, or/and via bluetooth
Softstart	Yes
Dimming level memory	Yes, also after disconnect mains
Protection over temperature	Yes, automatic recovery after removal of faults
Mount	Built-in mounting box or wall mounting
Working humidity	0~80%
Working temperature	-20 ~ 50°C
Dimension	48.5 x 50 x 15.5 mm
Weight	29g
Housing	
- colour	White
- material	Polyamid plastics
- flame class	V-0
For dimming of	For dimmable low energy lamps, 230V LED, electronic transformers, LED-drivers, incandescent light and 230V halogenlamps. <i>Do not forget to take into account the reactive power in the calculation of the load.</i>
Dimming range	1 - 100%
Adjustable minimum dimming level	Yes
Isolation class	IP20
Protection index	II
Approvals	CE/S
Manufacturing standard	EN60669

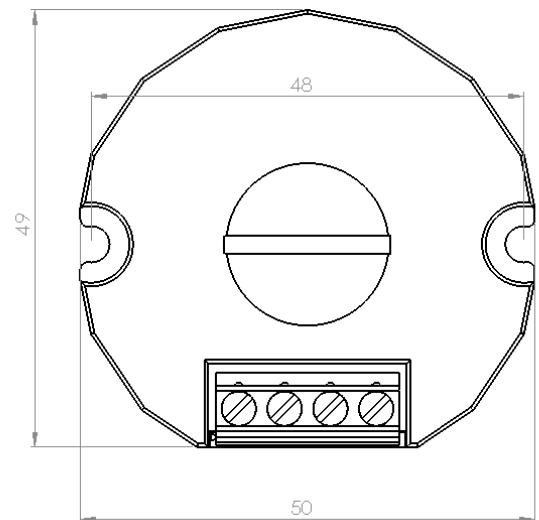
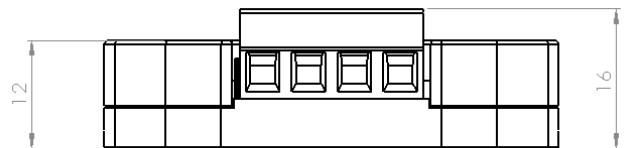

VADSBO  powered by **CASAMBI** — A complete ecosystem for all lighting