

INDRE



Rakumba

MATERIALS & FINISHES

“Colour and material was important for me to further connect the series with interior environments. I wanted to link lighting and architecture to create a system that enhances the spatial environment.”

———— **Nikolai Kotlarczyk**



GUNMETAL



GOLDEN



WHITE

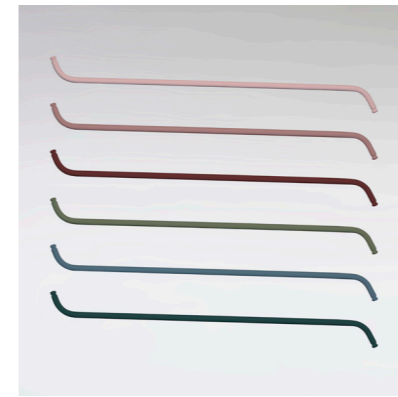

CUSTOM



FOREST GREEN MARBLE | SATIN



CLASSIC LIGHT TRAVERTINE (UNFILLED) | HONED



NERO MARQUINA | POLISHED



CARRARA | HONED



OAK | SATIN

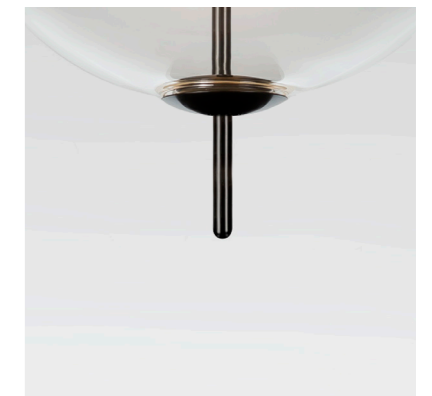

FINIAL



OPTIONS

MODULAR PENDANT SYSTEM

CONFIGURATION:	<input type="radio"/>	A - V	
METALWORK:	<input type="radio"/>	GUNMETAL	
	<input type="radio"/>	GOLDEN	
	<input type="radio"/>	WHITE	
	<input type="radio"/>	CUSTOM	
ANCHOR:	<input type="radio"/>	FOREST GREEN MARBLE	
	<input type="radio"/>	CLASSIC LIGHT TRAVERTINE	
	<input type="radio"/>	NERO MARQUINA	
	<input type="radio"/>	CARRARA	
	<input type="radio"/>	OAK	
	<input type="radio"/>	FINIAL	
DIMMING:	<input type="radio"/>	NON DIMMABLE (REMOTE DRIVER)	
	<input type="radio"/>	PHASE CUT/TRIAC (REMOTE DRIVER)	
	<input type="radio"/>	DALI/SWITCH-DIM (REMOTE DRIVER)	
	<input type="radio"/>	1-10V (REMOTE DRIVER)	
	<input type="radio"/>	CASAMBI WIRELESS	
STANDARD SUSPENSION LENGTH VARIATIONS: (TO TOP OF MODULE)	<input type="radio"/>	160MM	<input type="radio"/>
	<input type="radio"/>	240MM	<input type="radio"/>
	<input type="radio"/>	375MM	<input type="radio"/>
	<input type="radio"/>	455MM	<input type="radio"/>
	<input type="radio"/>	590MM	<input type="radio"/>
	<input type="radio"/>	660MM	<input type="radio"/>
	<input type="radio"/>	670MM	<input type="radio"/>
	<input type="radio"/>	740MM	<input type="radio"/>
	<input type="radio"/>	875MM	<input type="radio"/>
			<input type="radio"/>
		955MM	
		1090MM	
		1160MM	
		1170MM	
		1240MM	
		1375MM	
		1455MM	
		1590MM	
		1670MM	
			<input type="radio"/>
			CUSTOM
SEAMLESS CANOPY:	<input type="radio"/>	BLACK	
	<input type="radio"/>	WHITE	
	<input type="radio"/>	SILVER	
	<input type="radio"/>	BRASS	

TABLE LAMP

METALWORK:	<input type="radio"/>	GUNMETAL
	<input type="radio"/>	GOLDEN
	<input type="radio"/>	WHITE
	<input type="radio"/>	CUSTOM
ANCHOR/BASE:	<input type="radio"/>	FOREST GREEN MARBLE
	<input type="radio"/>	CLASSIC LIGHT TRAVERTINE
	<input type="radio"/>	NERO MARQUINA
	<input type="radio"/>	CARRARA
	<input type="radio"/>	OAK
DIMMING:	<input type="radio"/>	INLINE SWITCH DIMMING/CORD AND PLUG

CONFIGURATIONS

PENDANT

A

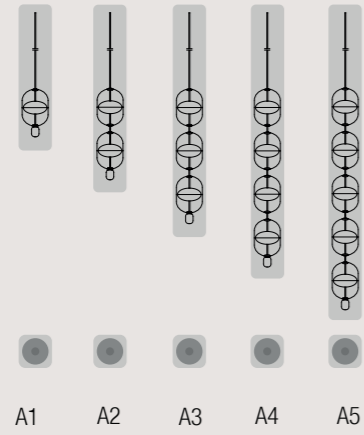

D

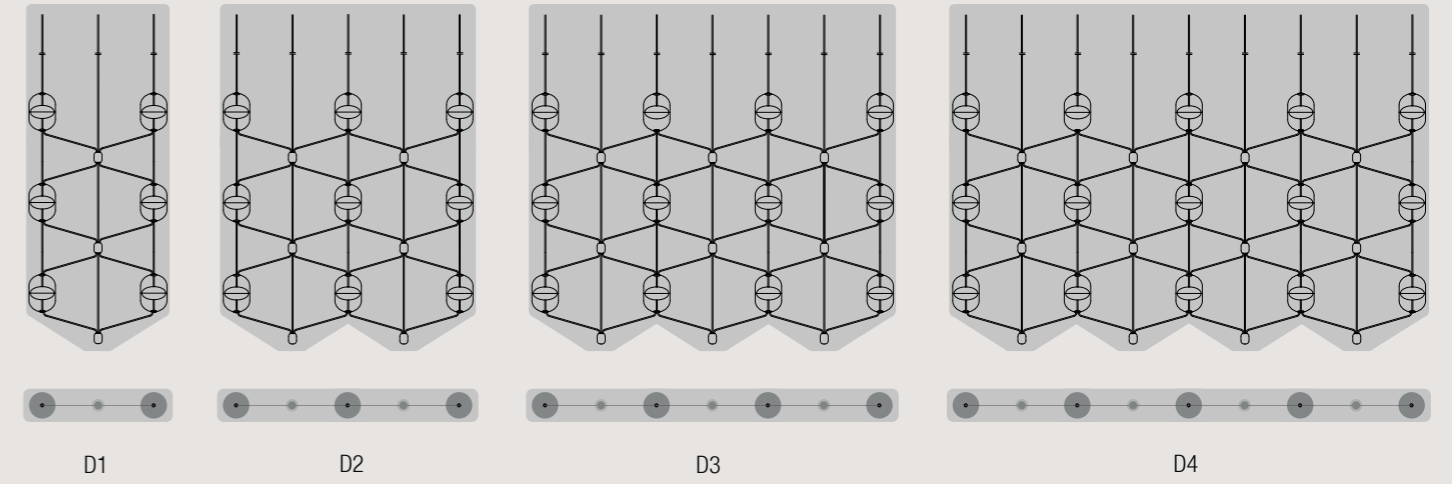

LINEAR CHANDELIERS

B

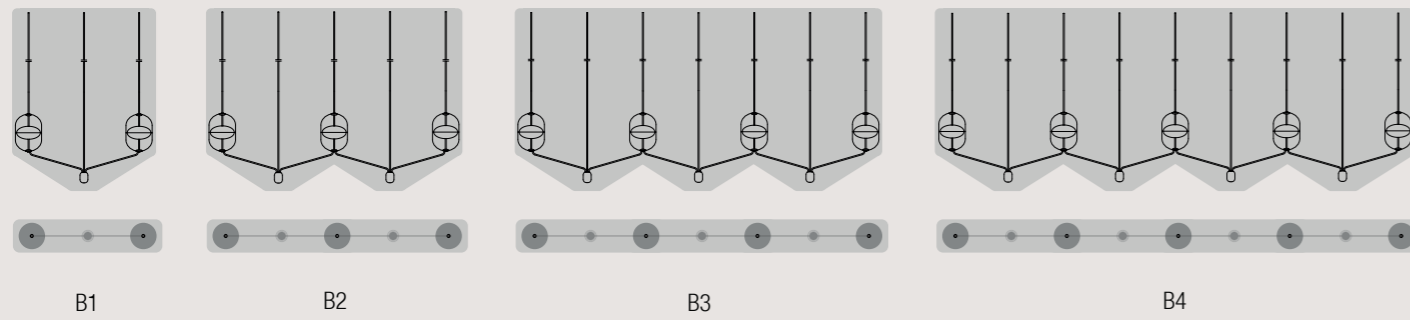

E

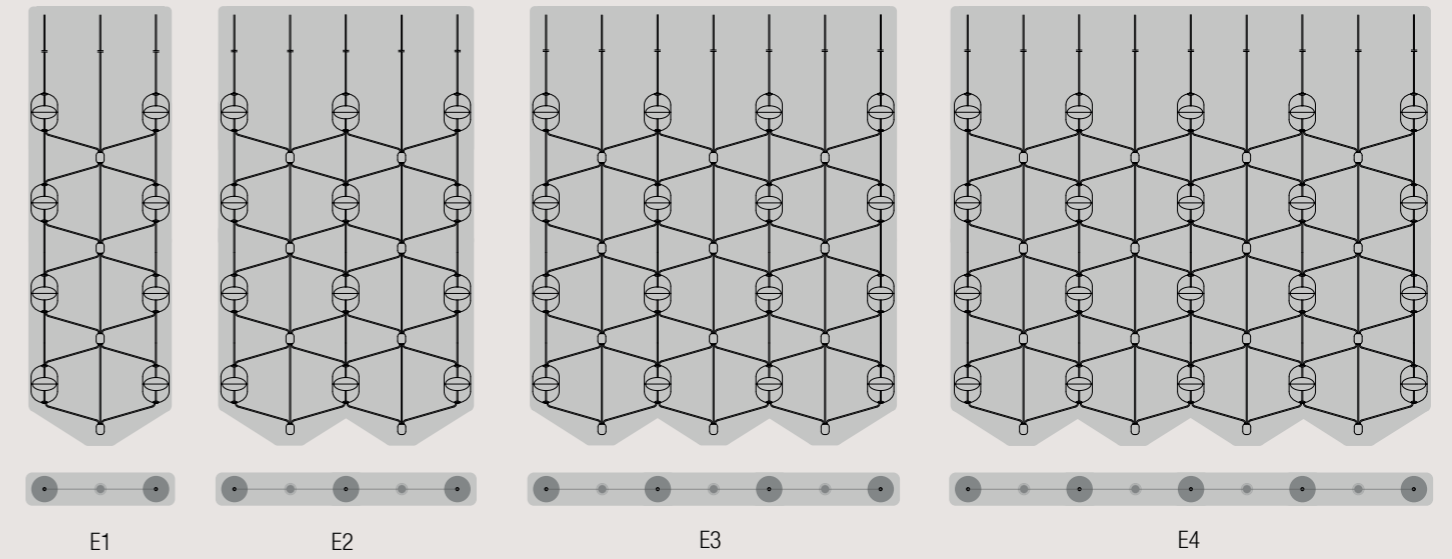

C

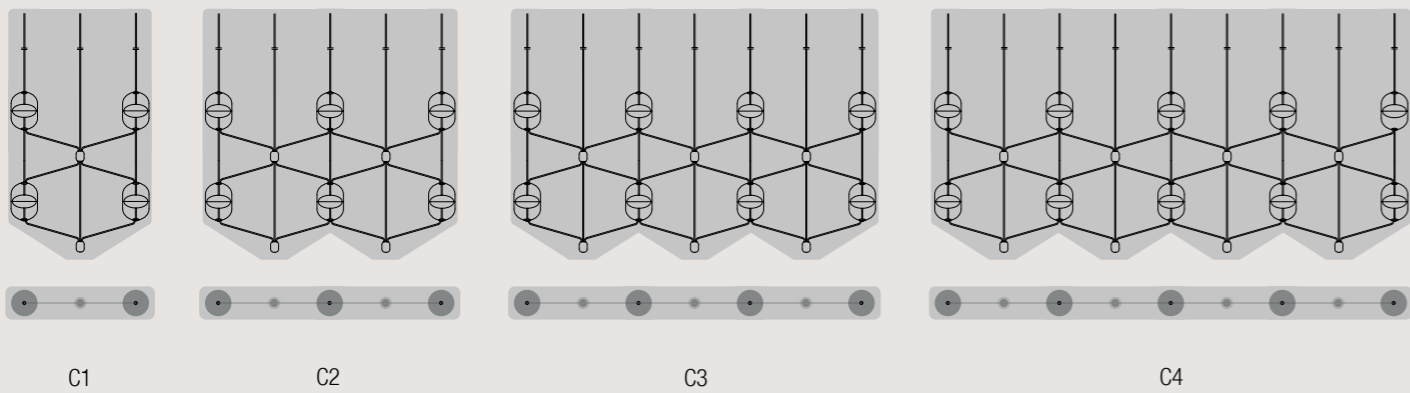

CONFIGURATIONS

LINEAR CHANDELIERS

F

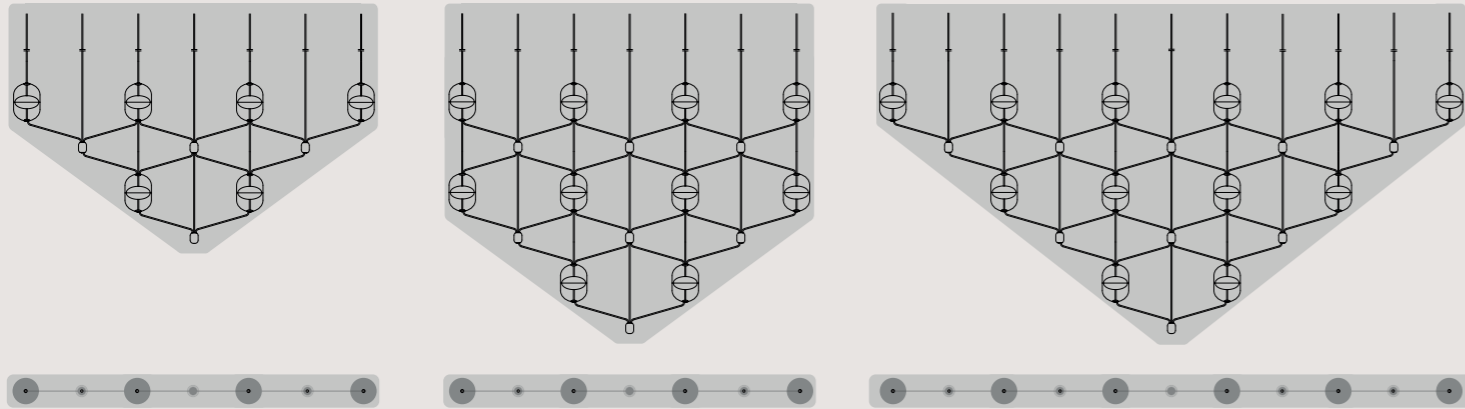

F1

F2

F3

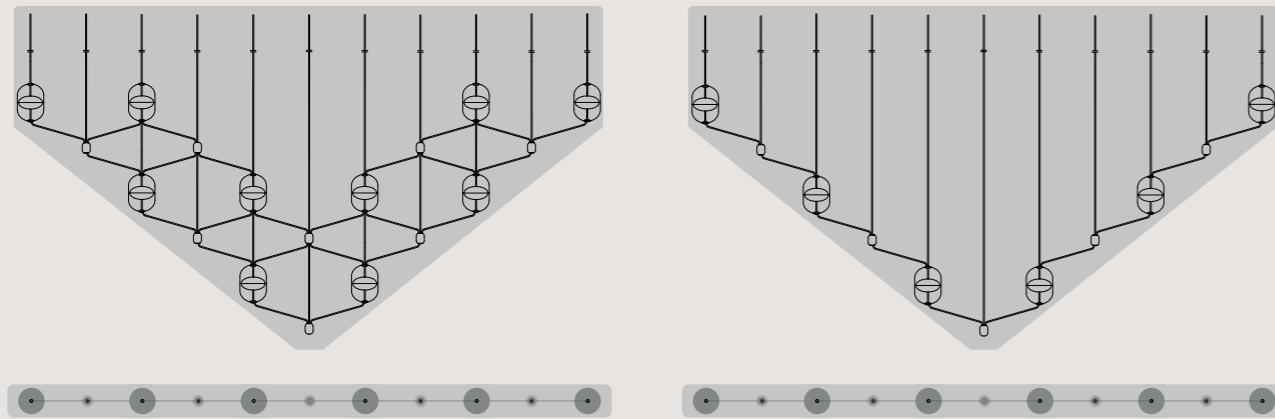

F4

F5

G

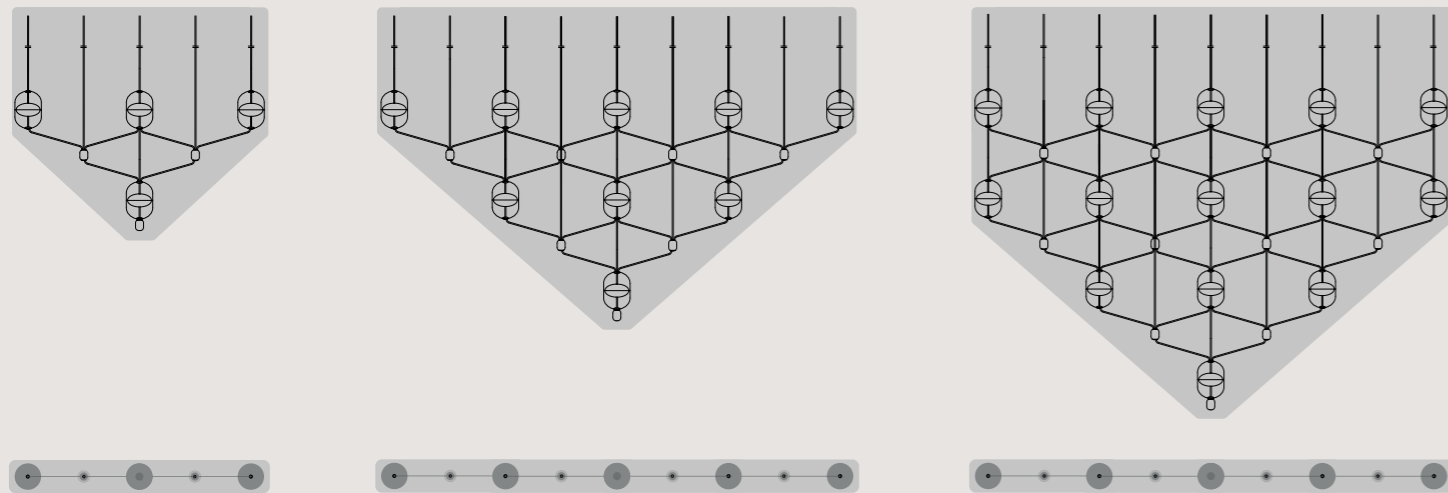

G1

G2

G3

H

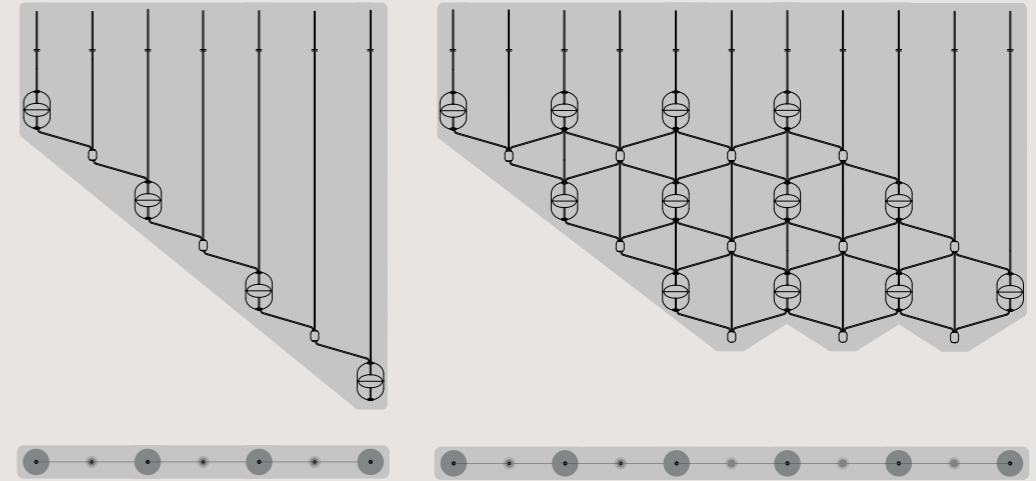

H1

H2

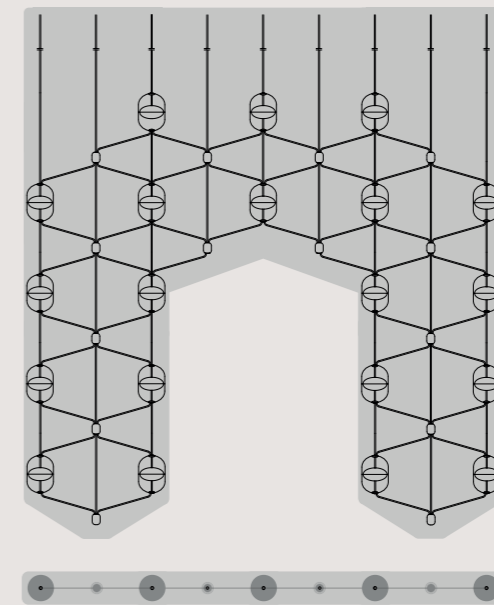

H3

CONFIGURATIONS

CHANDELIERS

I

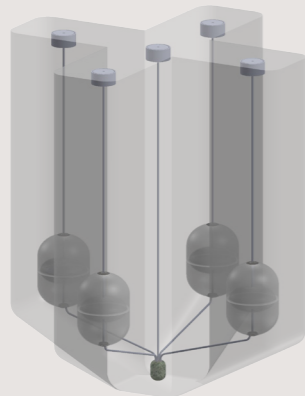

J

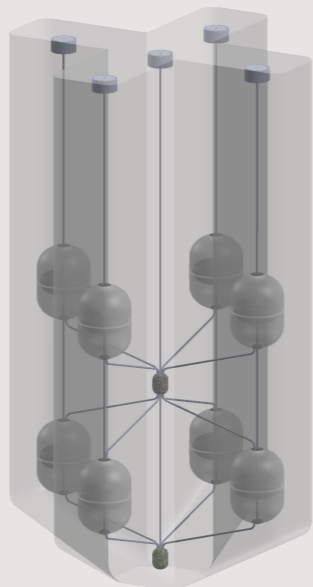

K

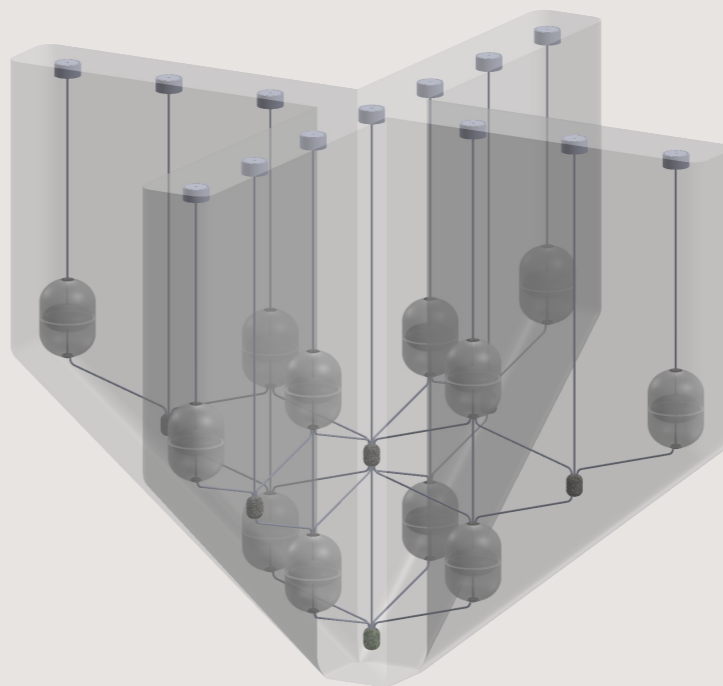

L

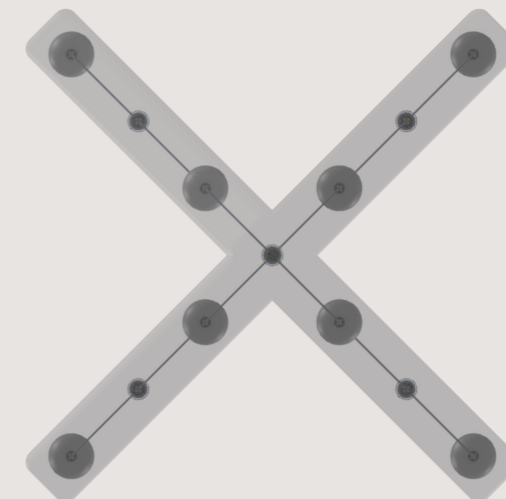
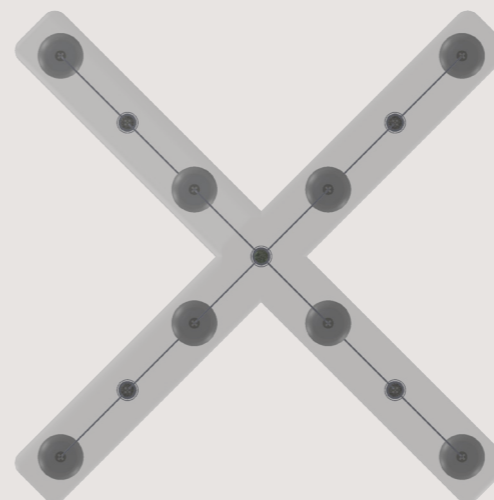
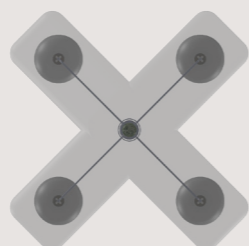
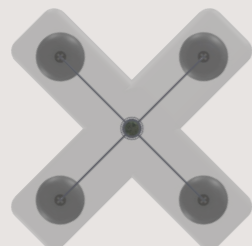
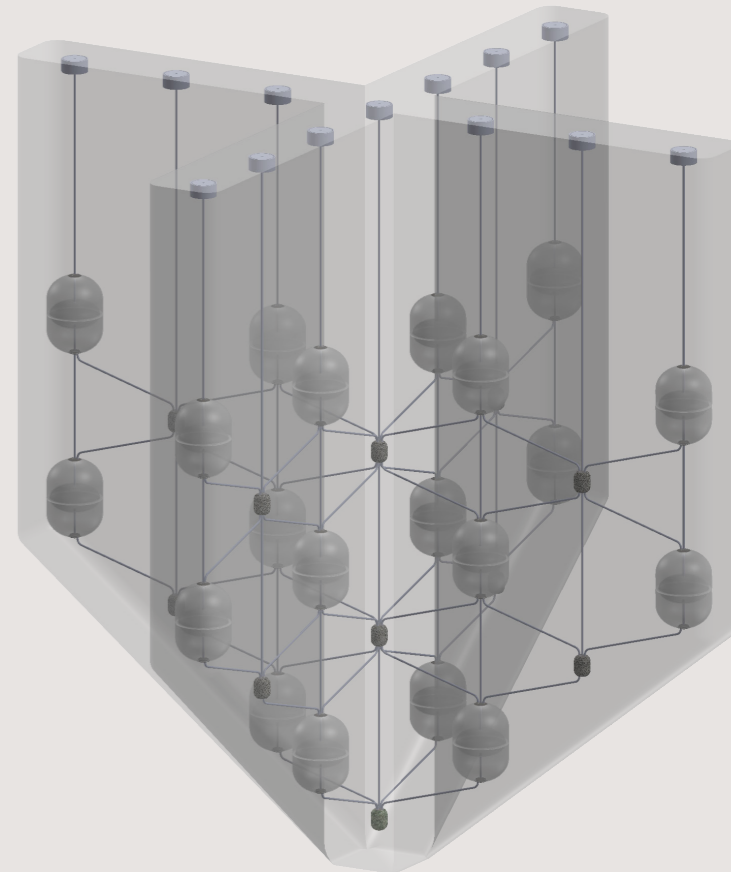

CONFIGURATIONS

CHANDELIERS

M

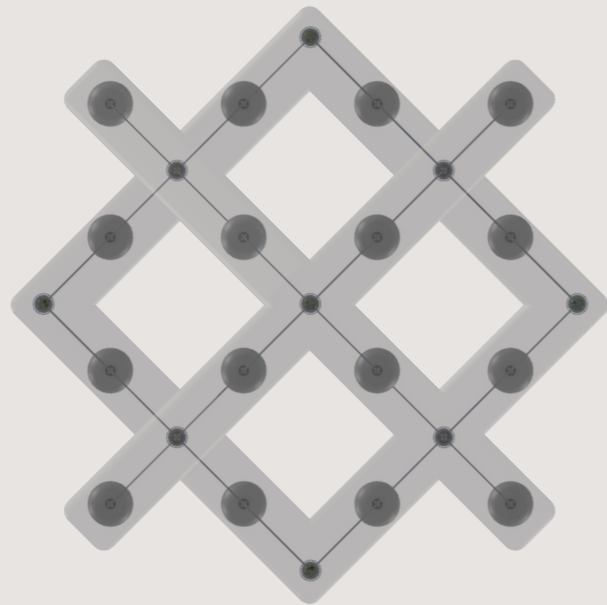
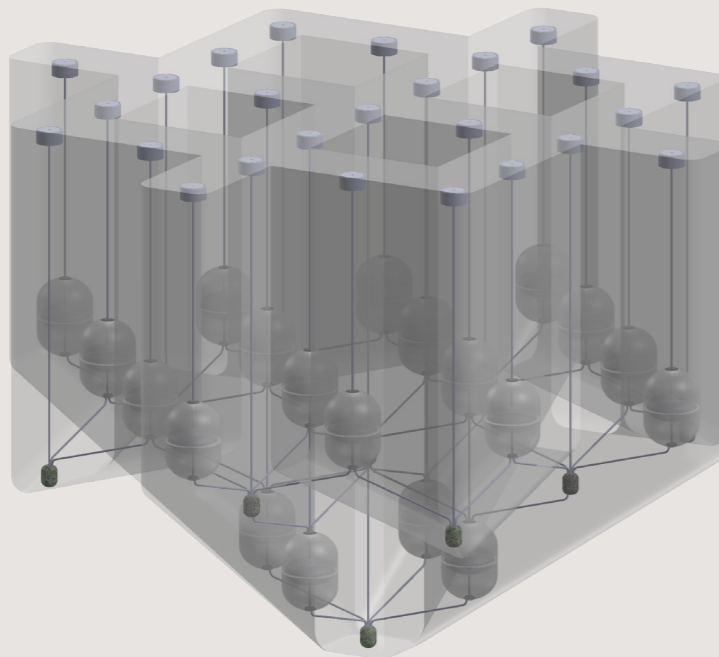

N

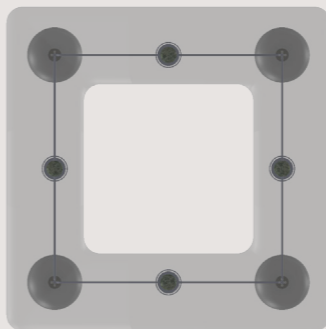
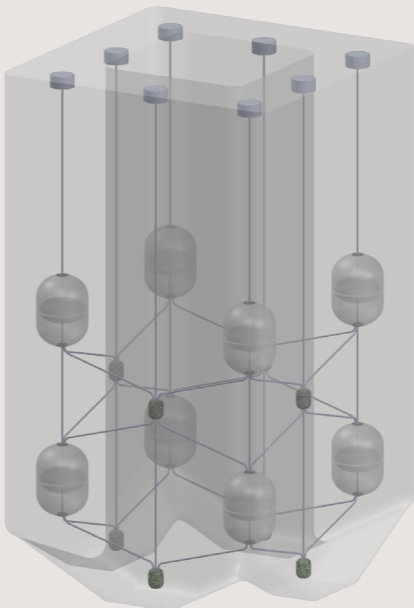

O

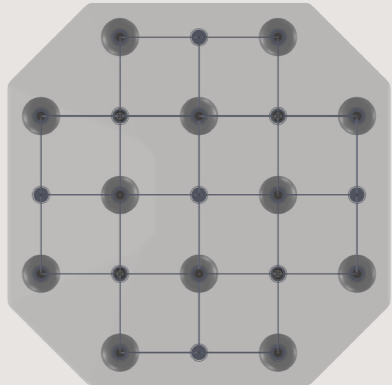
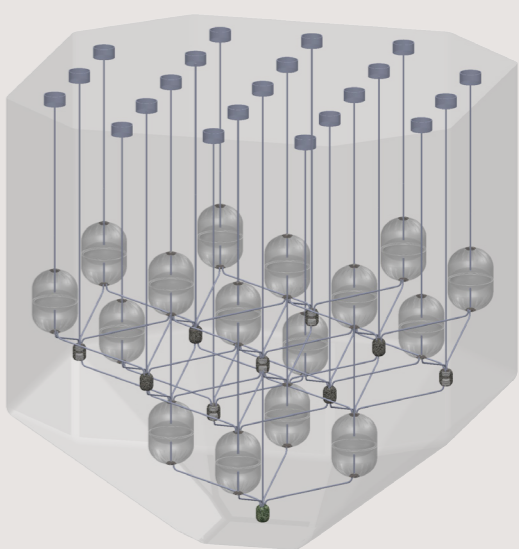

CONFIGURATIONS

CHANDELIERS

P

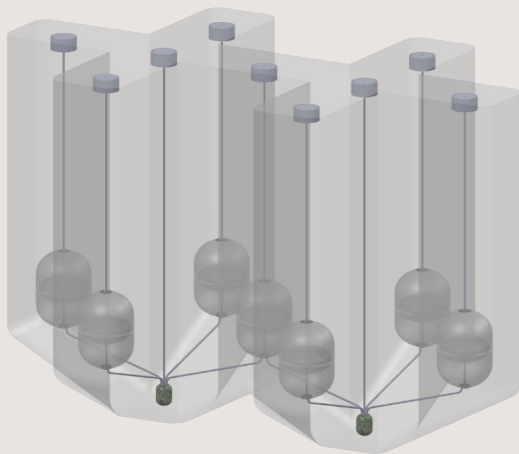

Q

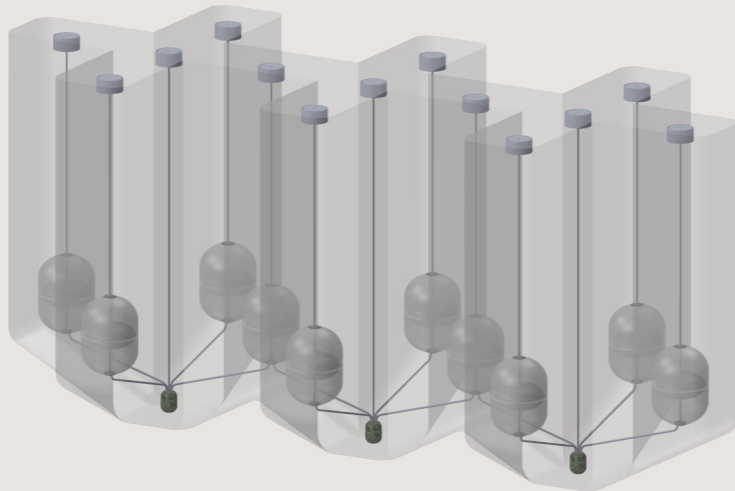

R

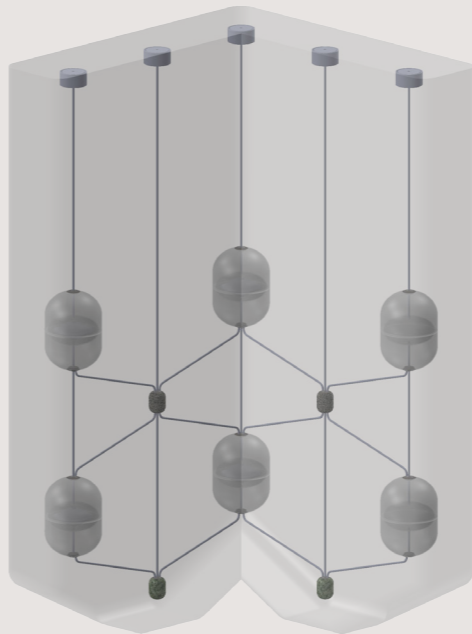

S

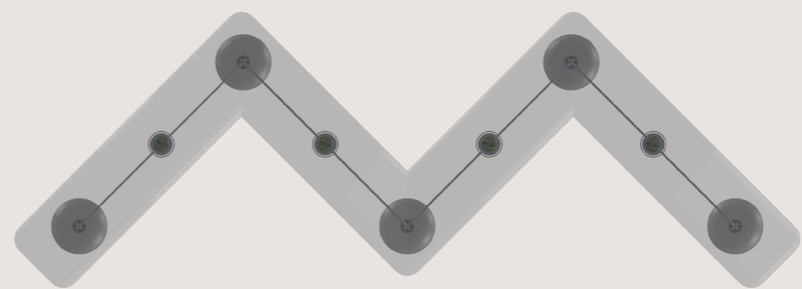
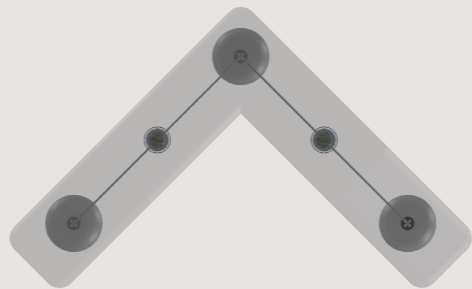
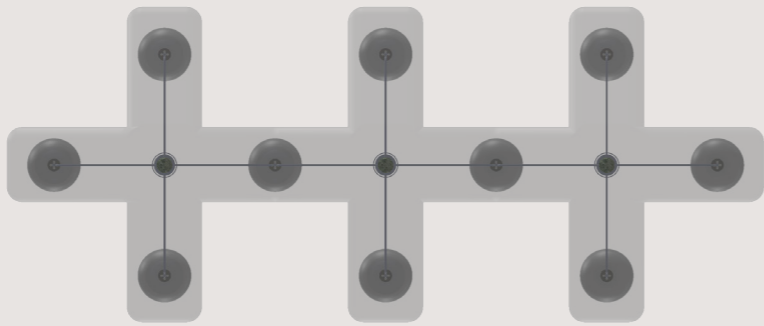
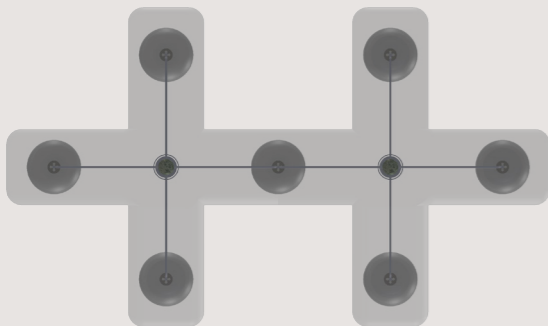
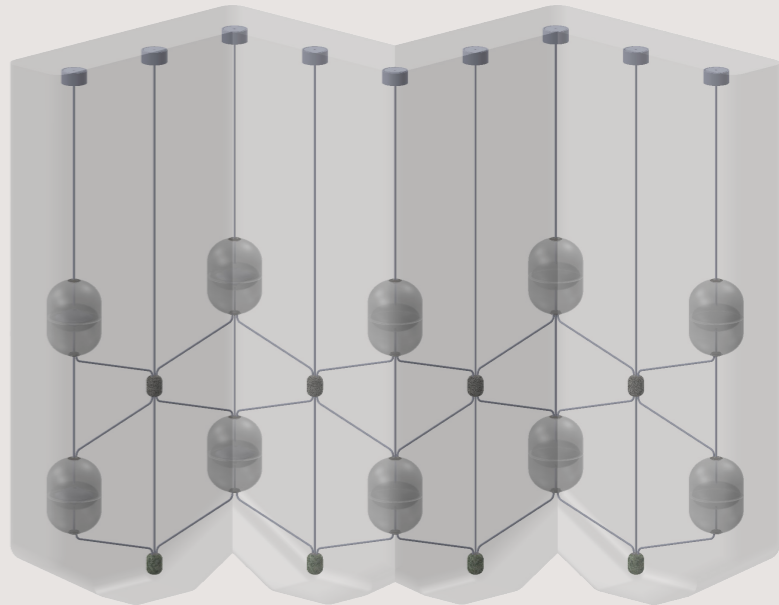

CONFIGURATIONS

CHANDELIERS

T

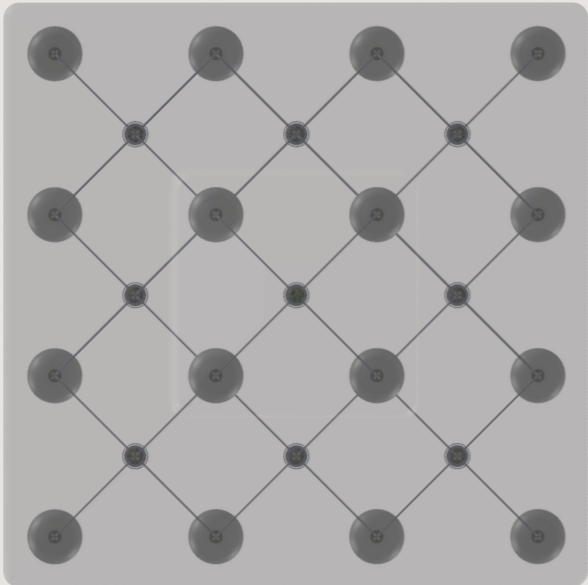
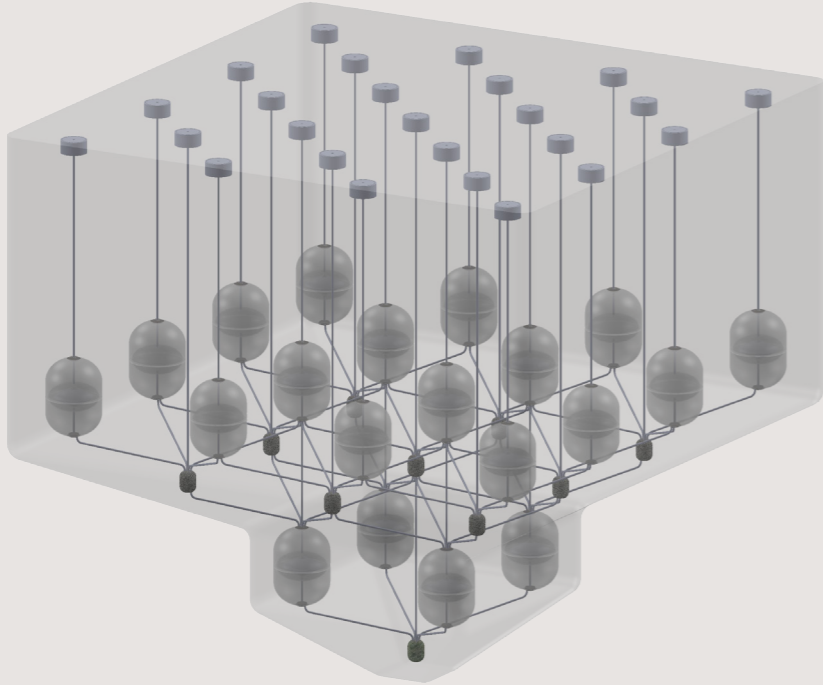

U

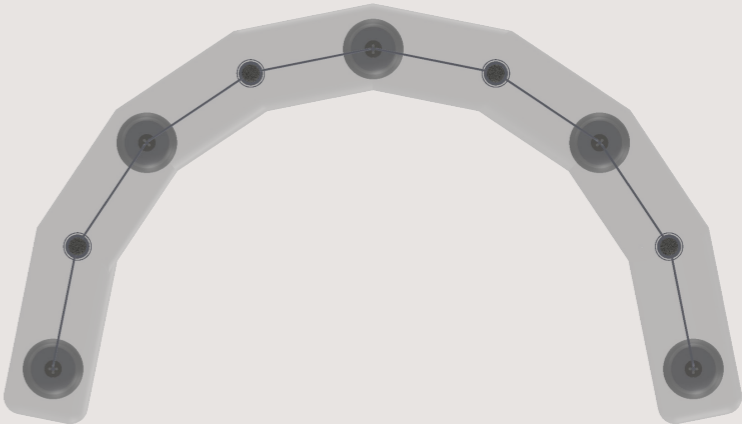
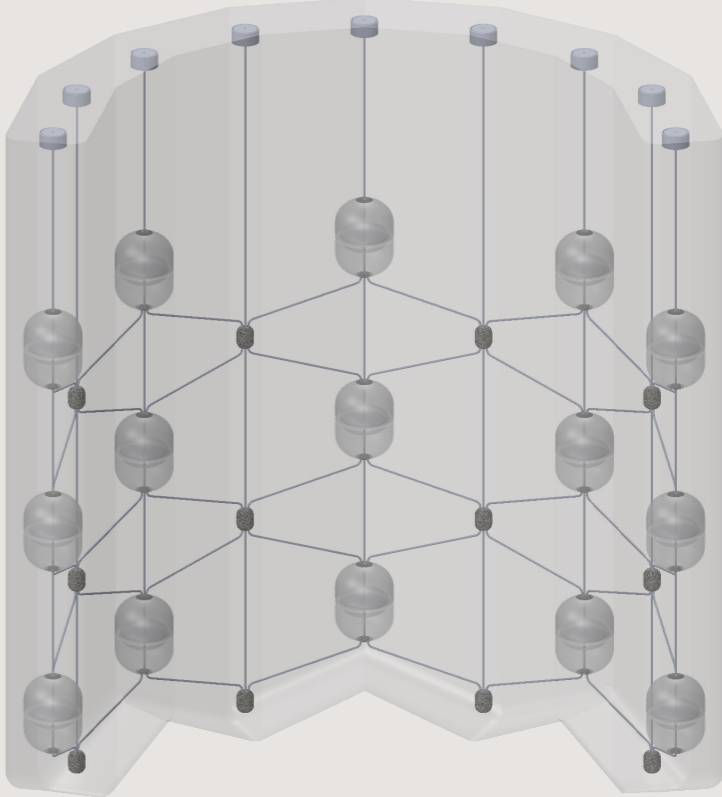

CONFIGURATIONS

CHANDELIERS

V

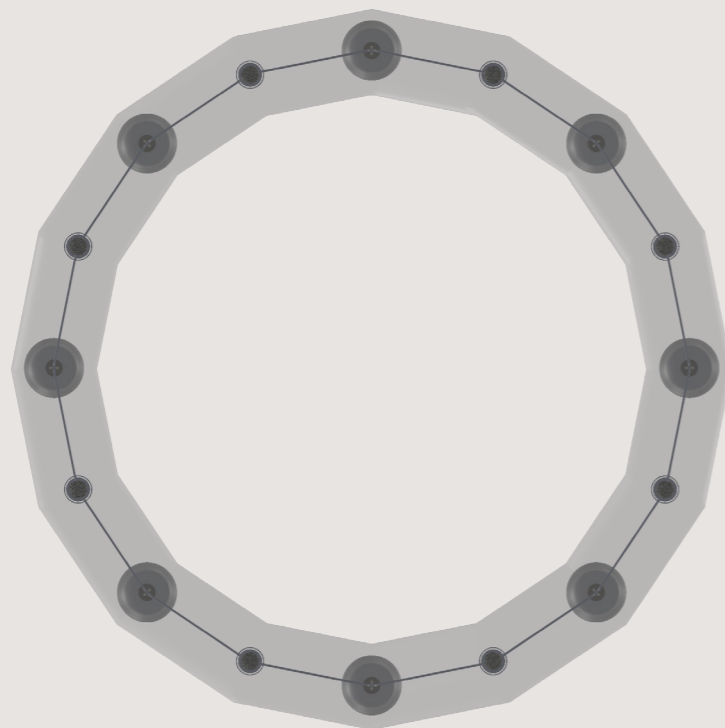
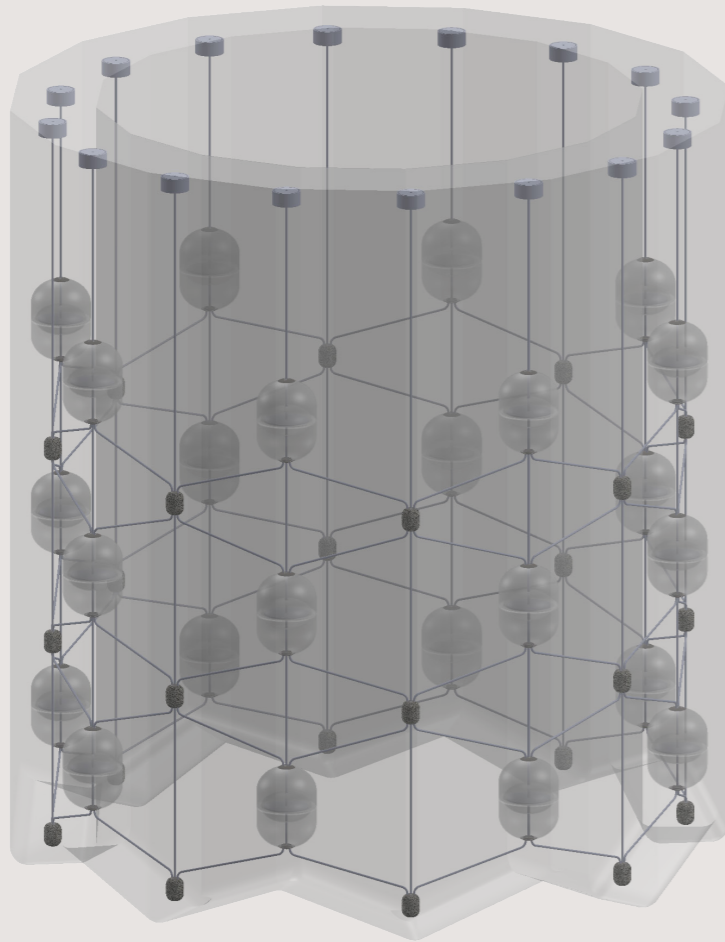

DETAIL

MODULAR SYSTEM ALLOWS FOR A MAXIMUM OF 4
DIAGONAL CONNECTOR RODS PER JUNCTION CAP

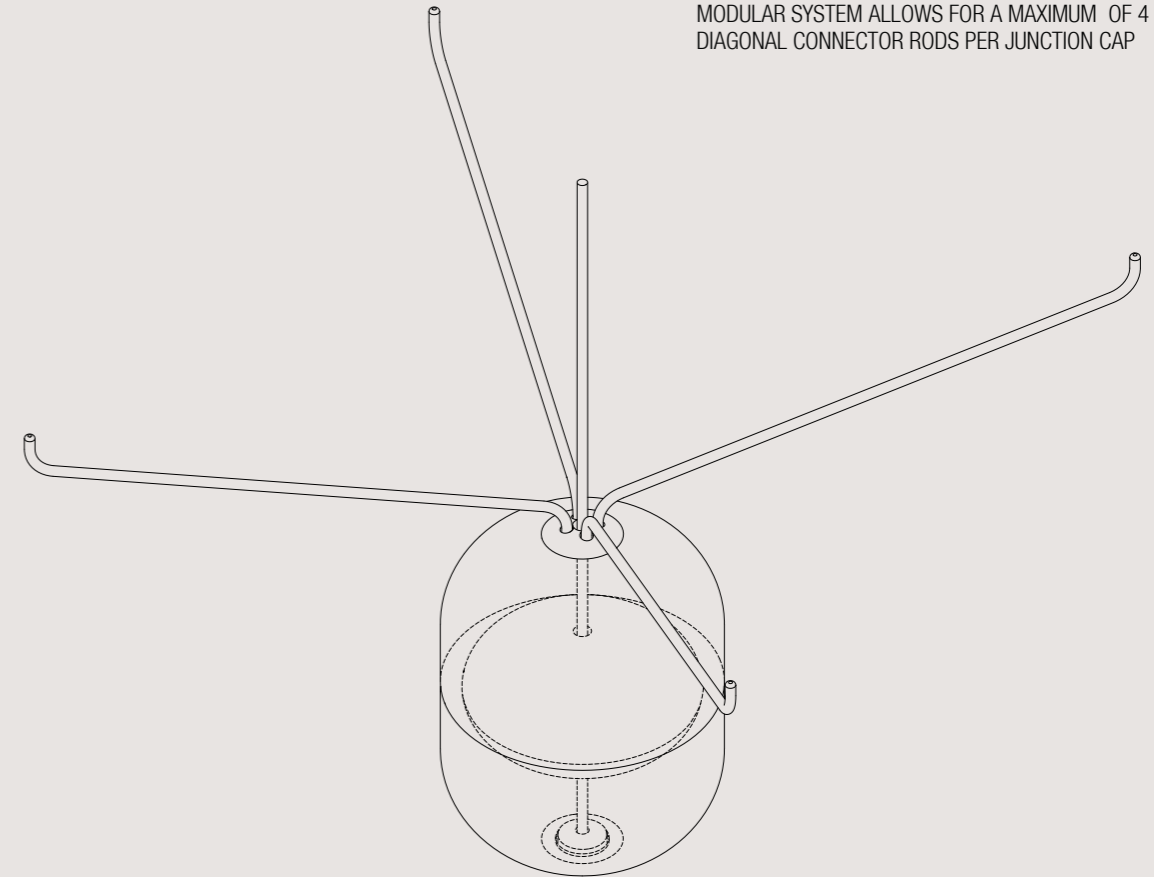

DIAGONAL CONNECTOR RODS CAN PIVOT FREELY -
ALLOWS FOR CURVED AND CIRCULAR CONFIGURATIONS

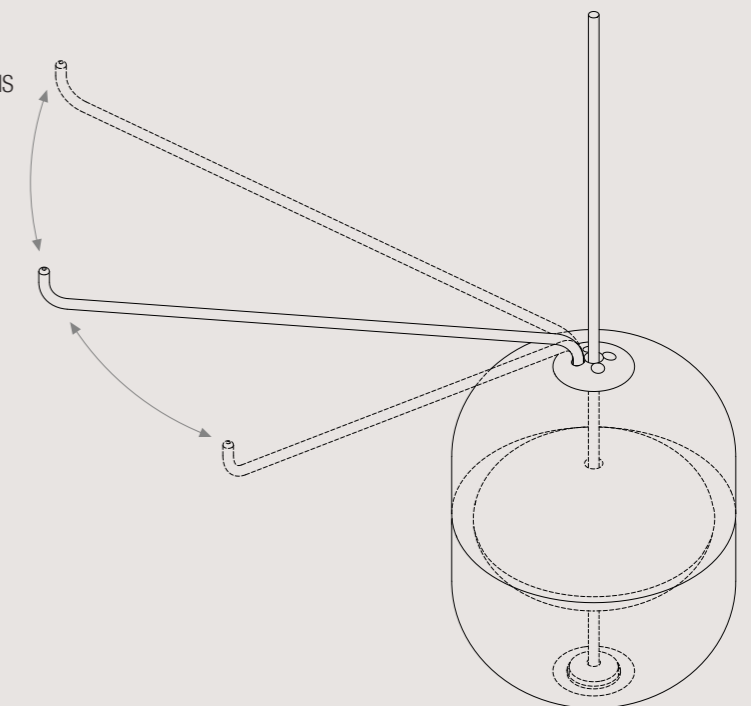

DIMENSIONS

MODULE

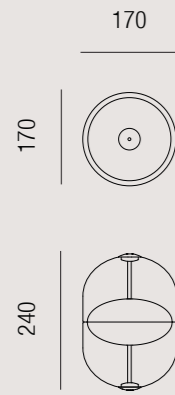
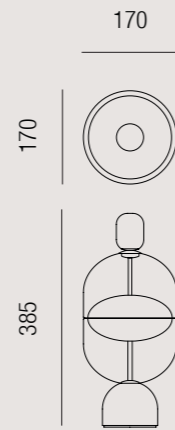
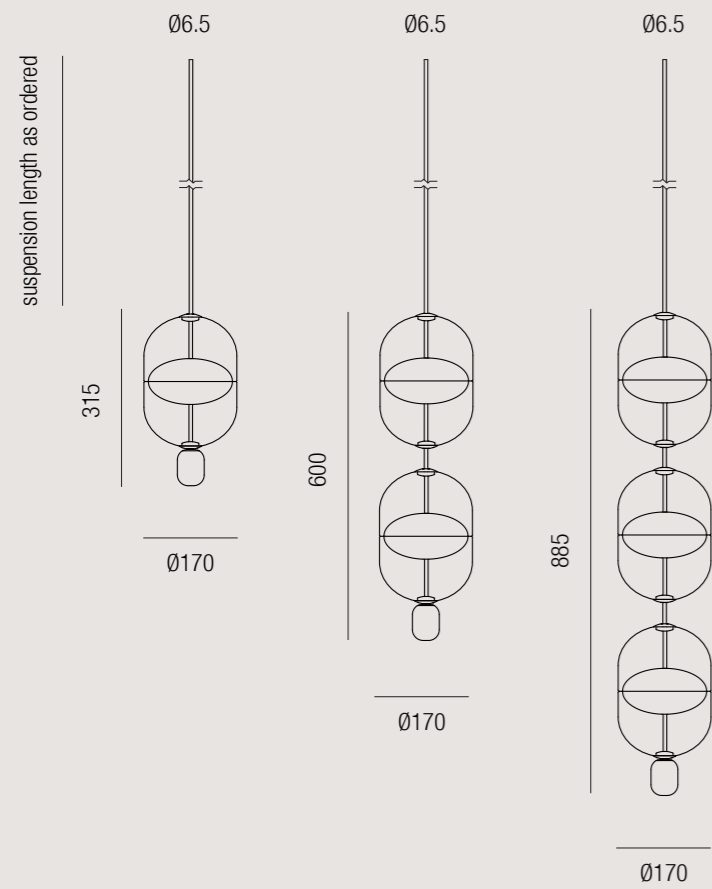

TABLE LAMP



PENDANT

MAXIMUM OF 8 LIGHT MODULES PER VERTICAL DROP
 MAXIMUM CONFIGURATION HEIGHT 6.5M



INDRE SYSTEM

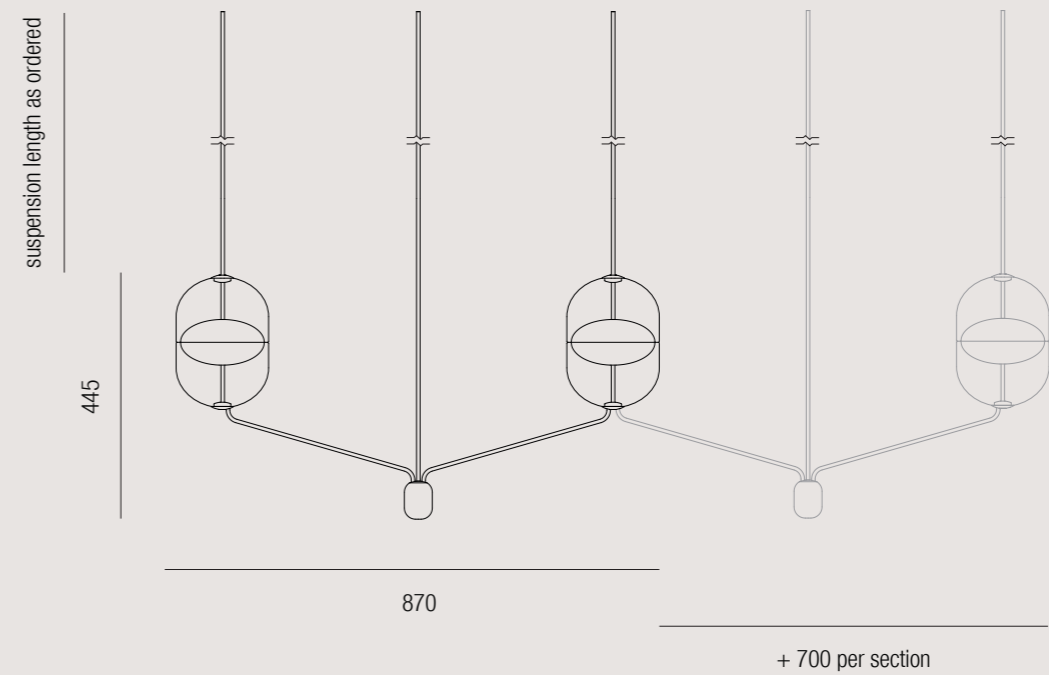
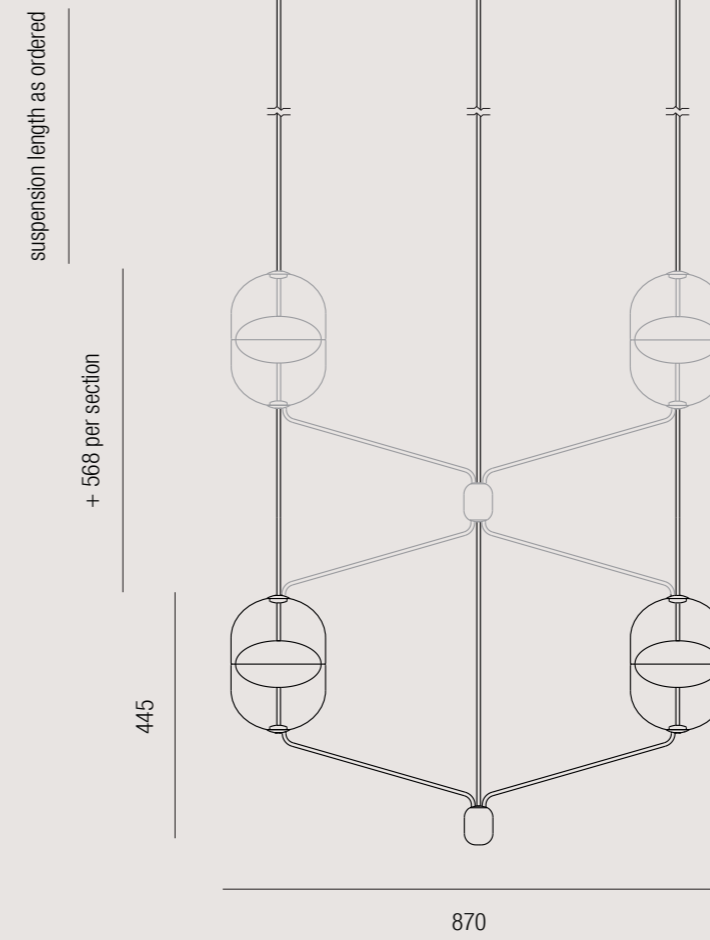

DATA

	SINGLE MODULE	TABLE LAMP
LIGHTSOURCE	INTEGRATED LED	
POWER	6.5W	6.5W
LUMENS (SOURCE)	870lm	870lm
LUMENS (DELIVERED)	-	-
COLOUR TEMPERATURE	2700K	
CRI	CRI90	
PRIMARY VOLTAGE (TO DRIVER)	220-240VAC	
SECONDARY VOLTAGE (TO FITTING)	24VDC CONSTANT VOLTAGE	
PRODUCT WEIGHT	0.9kg	2.3kg
PACKED WEIGHT (FITTING)	-	-
PACKED DIMENSIONS	-	-
DRIVER LOCATION	REMOTE	CORDSET DRIVER
IP RATING	IP20	
L70	50,000 HOURS	
APPROVALS	AUSTRALIA, EUROPE	

SINGLE DRIVER POWERS UP TO 4 LIGHT MODULES

LARGER DRIVERS (5-10 MODULES) AVAILABLE ON REQUEST

CONFIGURATION		NUMBER OF MODULES	PRODUCT DIMENSIONS	PRODUCT WEIGHT	PACKED DIMENSIONS	PACKED WEIGHT
A	1	1	315 x 170 x 170mm	2kg	-	-
	2	2	600 x 170 x 170mm	3kg	-	-
	3	3	885 x 170 x 170mm	4kg	-	-
	4	4	1170 x 170 x 170mm	5kg	-	-
	5	5	1455 x 170 x 170mm	6kg	-	-
B	1	2	445 x 870 x 170mm	4kg	-	-
	2	3	445 x 1570 x 170mm	5kg	-	-
	3	4	445 x 2270 x 170mm	7kg	-	-
	4	5	445 x 2970 x 170mm	9kg	-	-
C	1	4	1013 x 870 x 170mm	6kg	-	-
	2	6	1013 x 1570 x 170mm	9kg	-	-
	3	8	1013 x 2270 x 170mm	12kg	-	-
	4	10	1013 x 2970 x 170mm	16kg	-	-
D	1	6	1581 x 870 x 170mm	8kg	-	-
	2	9	1581 x 1570 x 170mm	13kg	-	-
	3	12	1581 x 2270 x 170mm	18kg	-	-
	4	15	1581 x 2970 x 170mm	23kg	-	-
E	1	8	2149 x 870 x 170mm	11kg	-	-
	2	12	2149 x 1570 x 170mm	17kg	-	-
	3	16	2149 x 2270 x 170mm	23kg	-	-
	4	20	2149 x 2970 x 170mm	29kg	-	-
F	1	6	1013 x 2270 x 170mm	10kg	-	-
	2	10	1581 x 2270 x 170mm	15kg	-	-
	3	12	1581 x 3670 x 170mm	19kg	-	-
	4	10	1581 x 3670 x 170mm	16kg	-	-
	5	6	1581 x 3670 x 170mm	11kg	-	-
G	1	4	890 x 1570 x 170mm	7kg	-	-
	2	9	1458 x 2970 x 170mm	14kg	-	-
	3	14	2026 x 2970 x 170mm	21kg	-	-
H	1	4	1956 x 2270 x 170mm	7kg	-	-
	2	12	1581 x 3670 x 170mm	20kg	-	-
	3	20	2717 x 2970 x 170mm	28kg	-	-

DATA

CONFIGURATION	NUMBER OF MODULES	PRODUCT DIMENSIONS	PRODUCT WEIGHT	PACKED DIMENSIONS	PACKED WEIGHT
I	4	445 x 870 x 870mm	6kg	-	-
J	8	1013 x 870 x 870mm	10kg	-	-
K	12	1013 x 2270 x 2270mm	18kg	-	-
L	20	1581 x 2270 x 2270mm	28kg	-	-
M	20	1013 x 2270 x 2270mm	30kg	-	-
N	8	1013 x 870 x 870mm	14kg	-	-
O	16	1013 x 1570 x 1570mm	26kg	-	-
P	7	445 x 1570 x 870mm	10kg	-	-
Q	10	445 x 2270 x 870mm	14kg	-	-
R	6	1013 x 1160 x 665mm	9kg	-	-
S	10	1013 x 2150 x 665mm	16kg	-	-
T	20	1013 x 2270 x 2270mm	31kg	-	-
U	15	1581 x 1057 x 1960mm	23kg	-	-
V	24	1581 x 1960 x 1960mm	39kg	-	-

